

Motion detector

IS 130-2

black
EAN 4007841 660215
Article number 660215



infrared sensor
130°



max. 12 m

600 W

600W max.



IP54



50° horizontal, 90°
vertical



2 - 2000 lux



8 sec - 35 min



Ideal 2 m



energy saving

3 years

manufacturer's
warranty steinel.de/
garantie

Function description

Targeted detection all around the building. Infrared motion detector IS 130-2, for indoors and out, ideal for targeted detection close to the building, 130° angle of coverage, reach up to 12 m, selectable time and twilight threshold, sensor turns through 50° and tilts through 90° for exact adjustment of the detection zone.

Technical specifications

Dimensions (L x W x H)	87 x 78 x 110 mm	LED lamps > 8 W	250 W
Manufacturer's Warranty	3 years	Capacitive load in µF	88 µF
Settings via	Potentiometers	Technology, sensors	passive infrared, Light sensor
With remote control	No	Mounting height	1,80 – 3,00 m
Version	black	Mounting height max.	3,00 m
PU1, EAN	4007841660215	Optimum mounting height	2 m
Type	Motion detectors	Detection angle	130 °
Application, place	Outdoors, Indoors	Angle of aperture	40 °
Application, room	outdoors, front door, all round the building, terrace / balcony, courtyard & driveway	Sneak-by guard	Yes
Colour	black	Capability of masking out individual segments	Yes
Colour, RAL	9005	Electronic scalability	No
Includes corner wall mount	No	Mechanical scalability	No
Installation site	wall	Reach, radial	r = 3 m (10 m ²)
Installation	Surface wiring, Wall	Reach, tangential	r = 12 m (163 m ²)
IP-rating	IP54	Switching zones	260 switching zones
Ambient temperature	from -20 up to 50 °C	Twilight setting	2 – 2000 lx

<https://www.steinel.de>

Subject to technical modifications

05.2025 Page 1 from 3

Motion detector

IS 130-2

black
EAN 4007841 660215
Article number 660215



Technical specifications

Material	Plastic
Mains power supply	230 – 240 V / 50 Hz
Switching output 1, resistive	600 W
Fluorescent lamps, electronic ballast	250 W
Fluorescent lamps, uncorrected	500 VA
Fluorescent lamps, series-corrected	500 VA
Fluorescent lamps, parallel-corrected	500 VA
Switching output 1, low-voltage halogen lamps	500 VA
LED lamps < 2 W	100 W
LED lamps > 2 W < 8 W	125 W

Time setting	8 s – 35 Min.
Basic light level function	No
Main light adjustable	No
Twilight setting TEACH	No
Constant-lighting control	No
Interconnection	Yes
Type of interconnection	Master/master
Interconnection via	Cable
Product category	Motion detector

Motion detector

IS 130-2

black
EAN 4007841 660215
Article number 660215



Detection Zone

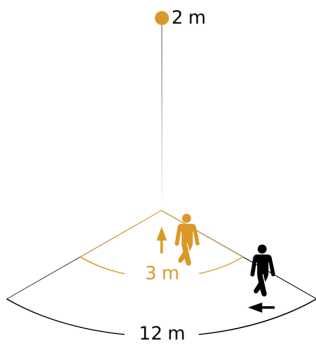

Possible mounting height: 1,80 m - 3,00 m
Orange: radial
Black: tangential

Dimension Drawing

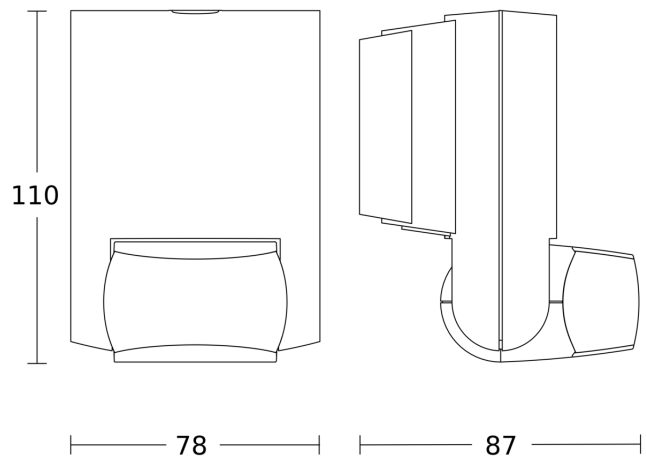

Light without neutral conductor

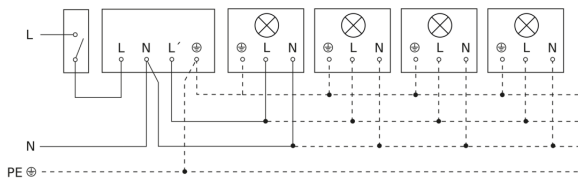

Light with neutral conductor



Connection using two-circuit switch for manual and automatic operation

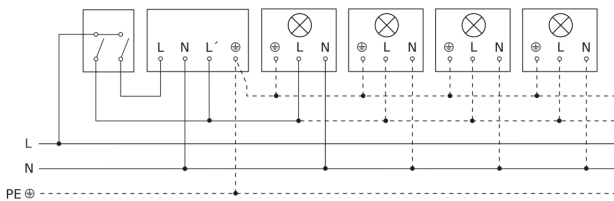

Circuit diagram Connection via a changeover switch for continuous and automatic operation

